

## C Connectors

With bayonet-lock coupling, it is easy and sure to mate/unmate. C connectors are medium size with 50Ω impedance. 75Ω cable can be used at lower frequencies (below 300MHz) where no serious mismatch is introduced.

Standard Specifications		MIL-STD-348A	
Nominal impedance		50Ω	
Frequency Range		DC~11GHz	
VSWR		1.35以下	
Maximum Working Voltage		AC1000V 2A current max @100MHz (depending on cable)	
Dielectric withstanding voltage		AC 2500V 1 minute	
Insulation resistance		5000MΩ min	
Temperature range		-65℃~+165℃	
Mating type		2 Stud Bayonet Coupling Lock	
Weather proof gasket		Silicone rubber	
Cable interface type		RG213 RG214 RG8 RG9 RG11 RG225 RG393	
Material	Shell	Brass	Gold plated, Nickel plated
	Center Socket Contact	Beryllium copper	Heat treated, Gold plated

Above characteristics are typical but may not apply to all connectors.

### Interface Dimensions

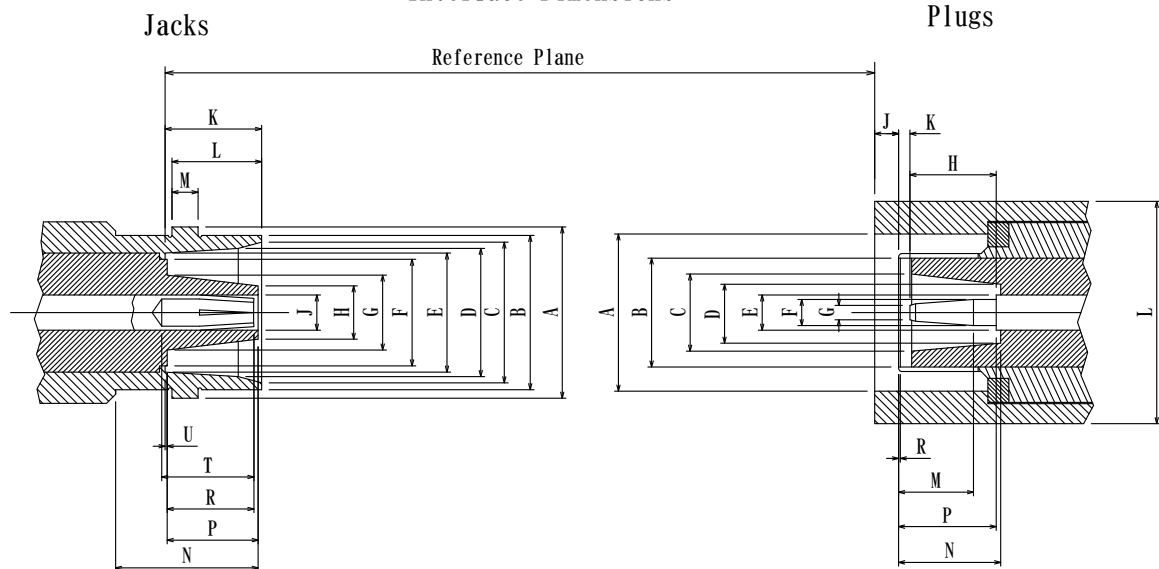

	Plug	
	min	max
A	14.99/0.590"	15.24/0.600"
B	13.46/0.530"	13.72/0.540"
C	12.32/0.485"	12.57/0.495"
D	11.18/0.440"	11.43/0.450"
E	10.44/0.411"	10.54/0.415"
F	-	9.50/0.374"
G	-	6.91/0.272"
H	-	4.83/0.190"
J	3.02/0.119"	3.15/0.124"
K	8.43/0.332"	8.59/0.338"
L	7.80/0.307"	7.95/0.313"
M dia.	2.24/0.088"	2.49/0.098"
N	12.57/0.495"	-
P	-	7.85/0.309"
R	6.93/0.273"	7.70/0.303"
T	7.62/0.300"	-
U	-	0.18/0.007"

	Jack	
	min	max
A	13.79/0.543"	13.94/0.549"
B	9.58/0.377"	-
C	7.01/0.276"	-
D	4.93/0.194"	-
E	3.02/0.119"	3.15/0.124"
F	2.29/0.090"	2.34/0.092"
G	-	1.27/0.050"
H	7.54/0.297"	7.72/0.304"
J	-	2.16/0.085"
K	0.08/0.003"	1.02/0.040"
L	-	19.84/0.781"
M	4.85/0.191"	6.38/0.251"
N	7.85/0.309"	-
P	4.93/0.307"	8.56/0.337"
R	0.18/0.007"	-
T	3.33/0.131"	3.58/0.141"
V	2.62/0.103"	2.87/0.113"
W	0.25/0.010"	0.41/0.016"
X	2.64/0.104"	2.90/0.114"
Y	15.54/0.612"	-

## C Connectors

### Plug , Cable Clamp

CP-CBL-CL

Order to make

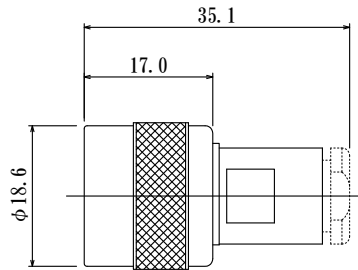

Applicable Cable  
RG58, RG55, RG141, RG142, RG223, RG400

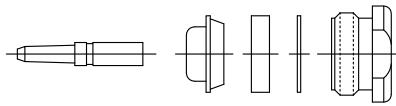

#### Material & Finish

Coupling Nut : Brass, Ni plating  
Shell : Brass, Ni plating  
Contact : Brass, Silver plating over Ni plating  
Insulator : PTFE

#### How to assemble

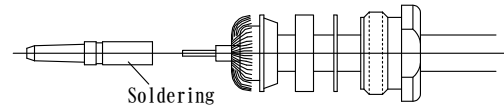

### Flange Mount , Receptacle

CJ-BK-UG634

Standard

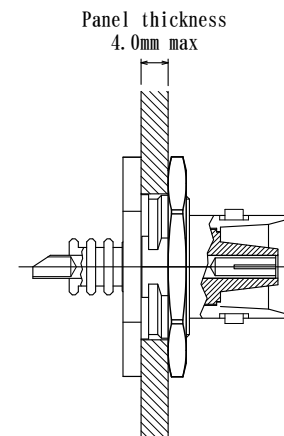
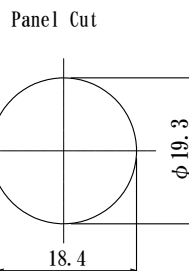
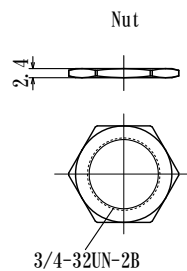
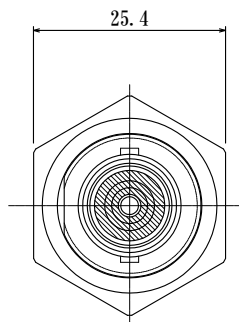
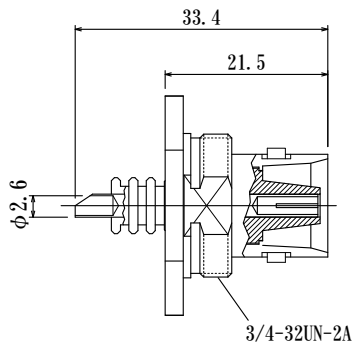

#### Material & Finish

Nut : Brass, Ni plating  
Shell : Brass, Ni plating  
Contact : Beryllium Copper, Silver plating over Ni plating  
Insulator : PTFE

\* mark product is made only upon order.