

**High Current Module $\phi 7.7\text{mm}/0.303''$ 2pin
UJC Series**

$\phi 7.7\text{mm}/0.303''$ module
Current rating : 80A at 25°C

Insulator P/N
UJC-M77X2-T250

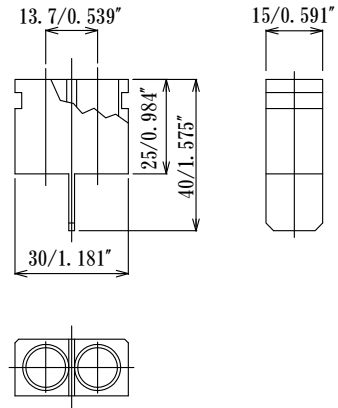

Dielectric strength : 1000V

Please call factory about followings
Crimping tool
Pin Removal tool

Socket pin P/N

Plug pin P/N

Crimping

Crimping



UJCS77-367F72LG-CR

UJCP77-525F8LG-CR

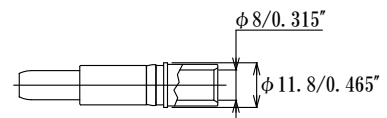
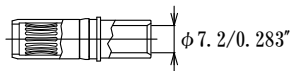

UJCS77-367F6LG-CR

UJCP77-525F72LG-CR *

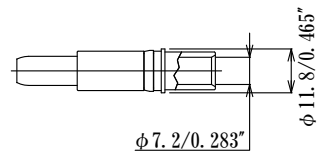
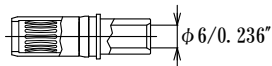

UJCP77-525F6LG-CR

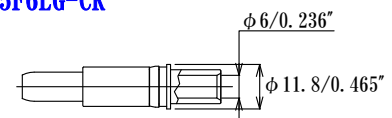

Gold plating

Gold plating

* mark product is made only upon order.

**High Current Module $\phi 8.0\text{mm}/0.315''$
UJC Series**

$\phi 8.0\text{mm}/0.315''$ connector
Current rating : 100A at 25°C

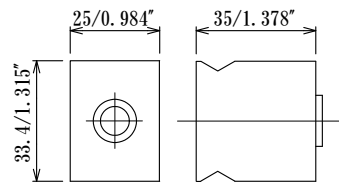
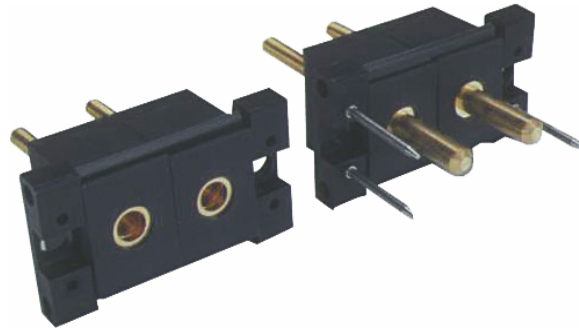

Insulator set P/N:
UJC-M80X1-T350
UJC-M80X1-T050

(Since two insulators are used together, please order both.)

Dielectric strength : 5000V

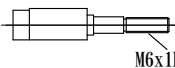
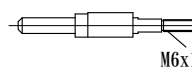
Pin type	Socket pin P/N	Plug pin P/N
Thread	UJCS80X2LV-71LG 	UJCP80-290LG 

Example of combination

