

Double ended probepin 両端プローブピン  
Outer Dia. 0.50~0.69mm/ 0.0197" ~ 0.027"

日本コネク  
TEL 03(5706)4360  
FAX 03(5706)4363

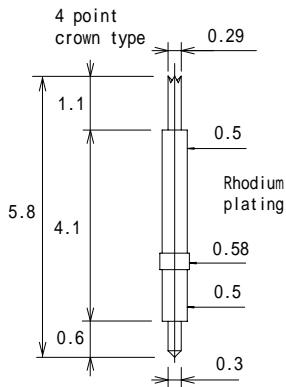

Preload 0.02N(2gf)  
Full travel 1.3mm  
0.26N(26gf) at 0.9mm travel

**8YF58L58G-RHI**

0.8mm pitch/ Field Adjacent  
Self inductance L1,L2 : 0.40nH  
Mutual inductance M21 : 0.05nH  
Mutual Capacitance C21: 0.06pF  
0.08pF

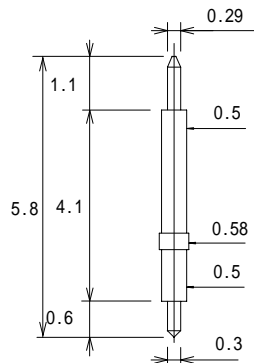

Preload 0.02N(2gf)  
0.29N(30gf) at 0.9mm travel

**8Y-F58L58-TPCRN**

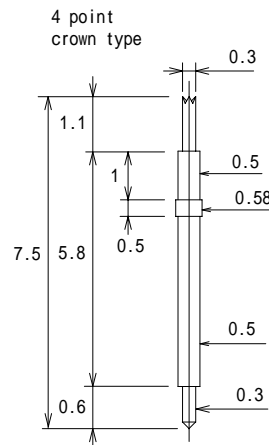

Preload 0.06N(6gf)  
Full travel 1.3mm  
0.29N(30gf) at 0.9mm travel

**8YF58L75I**

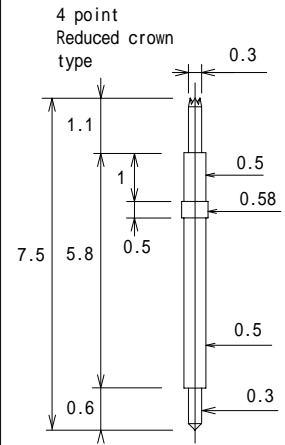

Preload 0.06N(6gf)  
Full travel 1.3mm  
0.29N(30gf) at 0.9mm travel

**8YF58L75-2I**

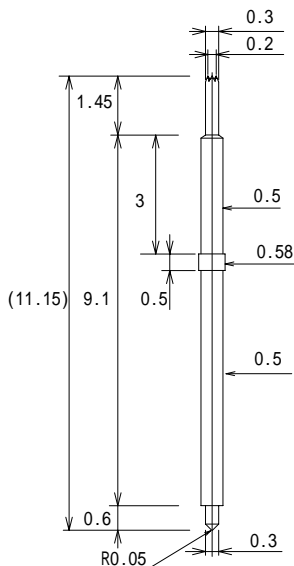

Full travel 1.3mm  
0.274N(28gf) at 0.8mm travel

**8YF58L1115-28G**

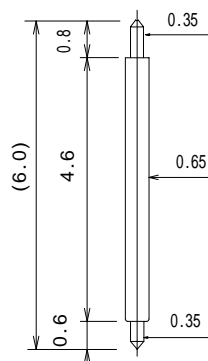

Full travel 1.1mm  
Preload 0.06N(6gf)  
0.29N(30gf) at 0.8mm travel

**8YF065L60I**

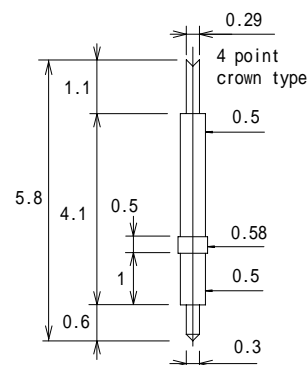

Preload 0.02N(2gf)  
0.29N(30gf) at 0.9mm travel

**8Y-F58L58G**

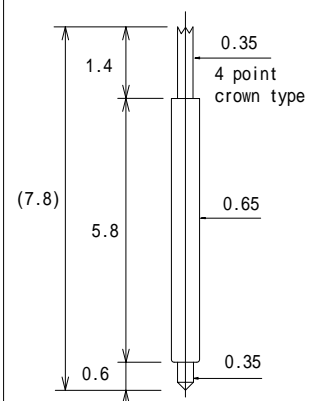

Preload 0.06N(6gf)  
Full travel 1.3mm  
0.29N(30gf) at 0.9mm travel

**8YF065L78-GI**

Double ended probepin 両端プローブピン  
Outer Dia. 0.50~0.69mm/ 0.0197" ~ 0.027"

日本コネクト  
TEL 03(5706)4360  
FAX 03(5706)4363

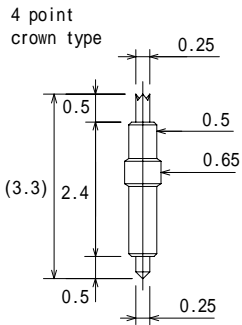

Full travel 0.9mm  
0.1N(10gf) at 0.9mm travel

**8YF65L33-CRCNI**

0.8mm pitch/ Field Adjacent  
Self inductance L1,L2 : 0.40nH  
Mutual inductance M21 : 0.05nH  
Mutual Capacitance C21: 0.06pF  
0.08pF

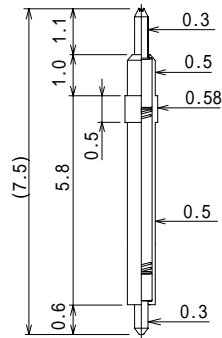

Full travel 1.1mm  
0.294N(30gf) at 0.9mm travel

**8YF58L75-2SUS**

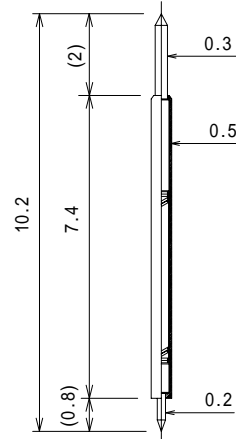

Full travel 2.8mm  
0.18N(18gf) at 1.8mm travel

**8YF50L102-2**

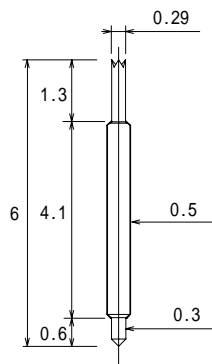

Full travel 1.3mm  
0.294N(30gf) at 0.8mm travel

**8YF58L60G-SA-S**

0.8mm pitch/ Field Adjacent  
Self inductance L1,L2 : 0.40nH  
Mutual inductance M21 : 0.05nH  
Mutual Capacitance C21: 0.06pF  
0.08pF

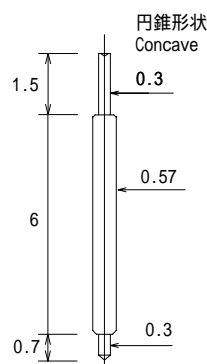

Preload 0.07N(7gf)  
0.22N(22gf) at 1.0mm travel

**8YD57L82L-WG**

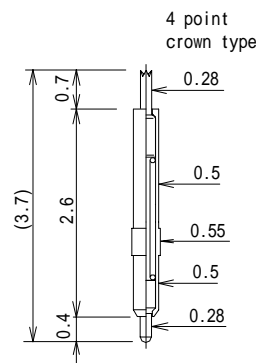

Full travel 0.65mm  
0.27N(27.5gf)  
at 0.55mm travel

**8YK-D50H-L37**

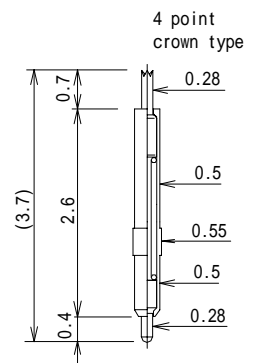

Full travel 0.65mm  
0.295N(30.1gf)  
at 0.55mm travel

**8YK-D50H-L37-30G**